

## Uni- and Bipolar Hall IC Switches for Magnetic Field Applications

TLE 4905 G; TLE 4935 G  
TLE 4935-2 G; TLE 4945-2 G

Bipolar IC

### Features

- Temperature compensated magnetic performance
- Digital output signal
- For unipolar and alternating magnetic fields
- Large temperature range
- Protection against reversed polarity
- Output protection against electrical disturbances

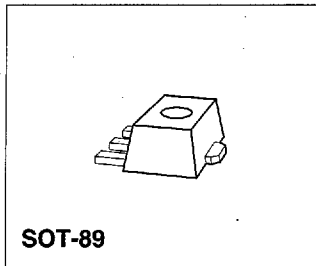

Type	Ordering Code	Package
TLE 4905 G	Q62705-K402	SOT-89
TLE 4935 G	Q62705-K404	SOT-89
TLE 4935-2 G	Q62705-K405	SOT-89
TLE 4945-2 G	Q62705-K403	SOT-89

TLE 4905/35/35-2/45-2 (Unipolar/Bipolar Magnetic Field Switches) have been designed specifically for automotive and industrial applications. Reverse polarity protection is included on-chip as is output protection against negative voltage transients.

Typical applications are position/proximity indicators, brushless DC motor commutation, rotational indexing etc.

■ 8235605 0134275 433 ■

**Pin Configuration**  
(top view)

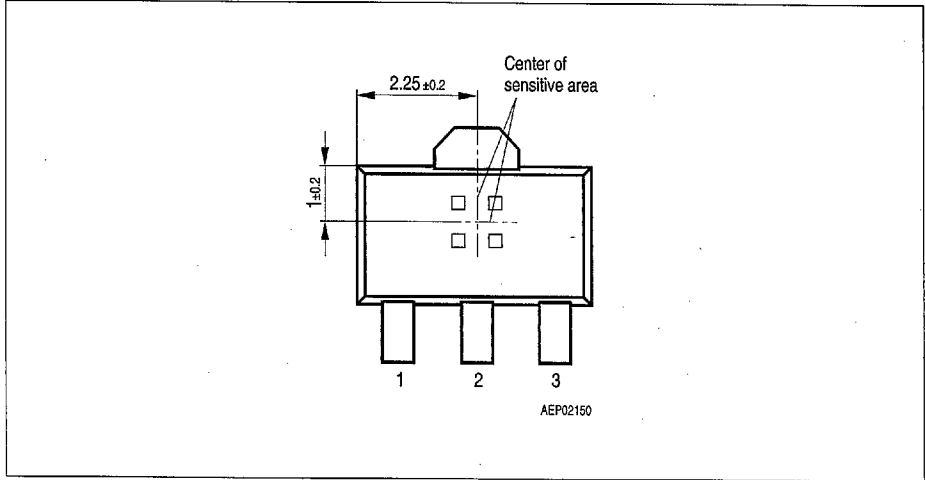

**Figure 1**

**Pin Definitions and Functions**

Pin No.	Symbol	Function
1	$V_s$	Supply voltage
2	GND	Ground
3	Q	Output

8235605 0134276 37T

### Circuit Description

The circuit includes Hall generator, amplifier and Schmitt-Trigger on one chip. The internal reference provides the supply voltage for the components. A magnetic field perpendicular to the chip surface induces a voltage at the hall probe. This voltage is amplified and switches a Schmitt-trigger with open-collector output. A protection diode against reverse power supply is integrated.

The output is protected against electrical disturbances.

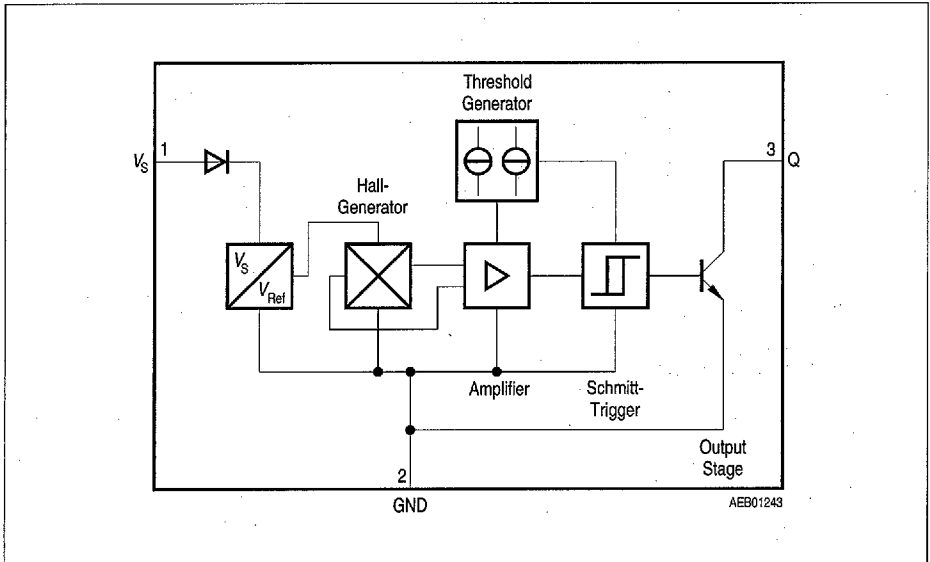

Figure 2 Block Diagram

8235605 0134277 206

### Functional Description Unipolar Type TLE 4905 (Figure 3 and 4)

When a positive magnetic field is applied in the indicated direction (Figure 3) and the turn-on magnetic induction  $B_{OP}$  is exceeded, the output of the Hall-effect IC will conduct (Operate Point). When the magnetic field is reduced to a value smaller than the release point, the output of the IC turns off (Release Point; Figure 4).

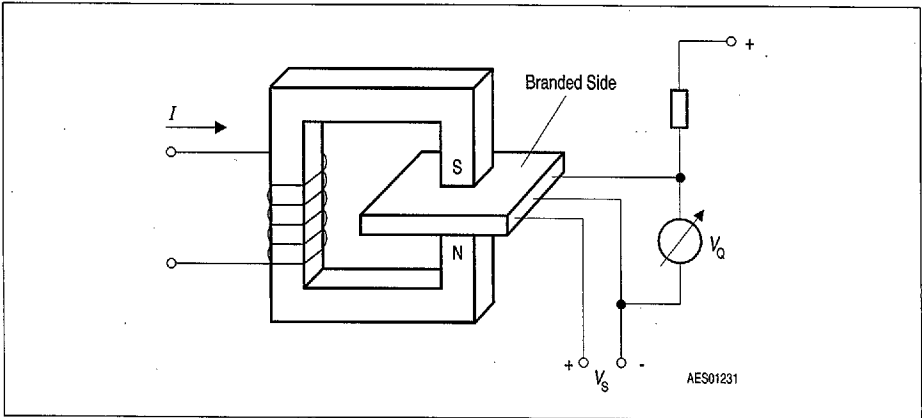

Figure 3 Sensor/Magnetic-Field Configuration

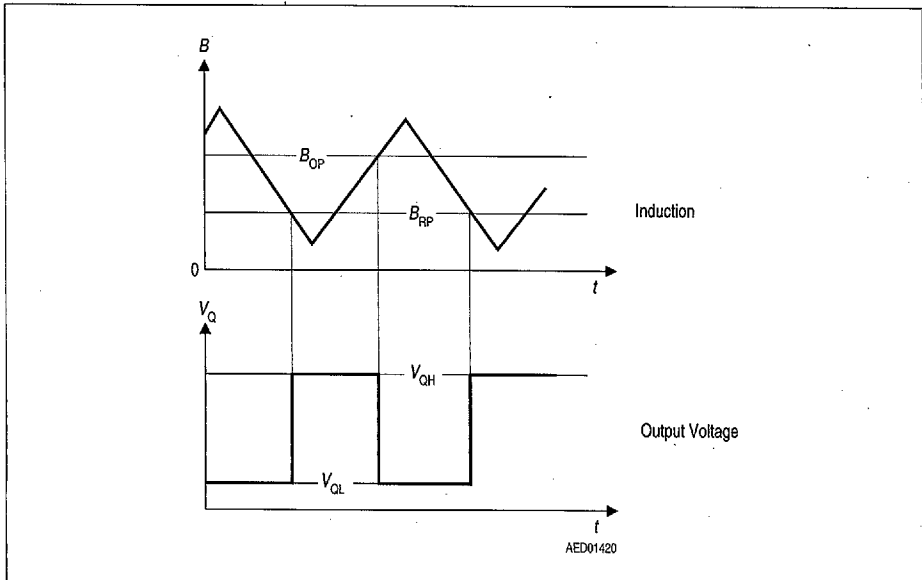
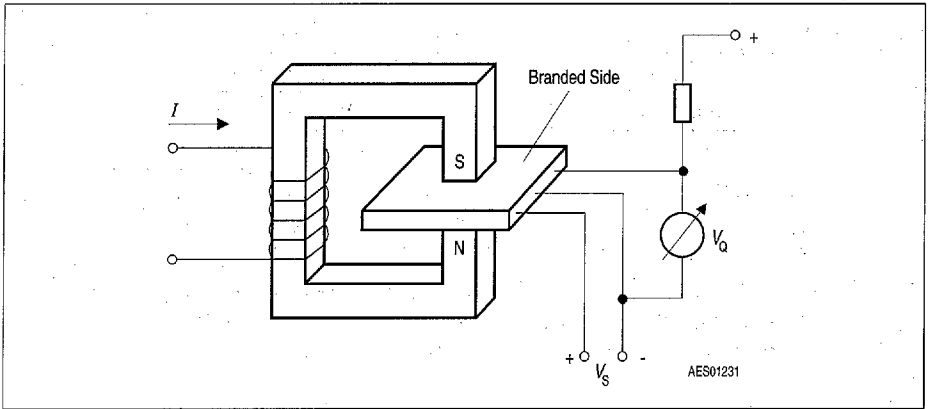

Figure 4 Switching Characteristics Unipolar Type

**Functional Description Bipolar Type TLE 4935/35-2/45-2 (Figure 5 and 6)**

When a positive magnetic field is applied in the indicated direction (**Figure 5**) and the turn-on magnetic induction  $B_{OP}$  is exceeded, the output of the Hall-effect IC will conduct (Operate Point). The output state does not change unless a reverse magnetic field exceeding the turn-off magnetic induction  $|B_{RP}|$  is exceeded. In this case the output will turn off (Release Point; **Figure 6**).



**Figure 5 Sensor/Magnetic-Field Configuration**

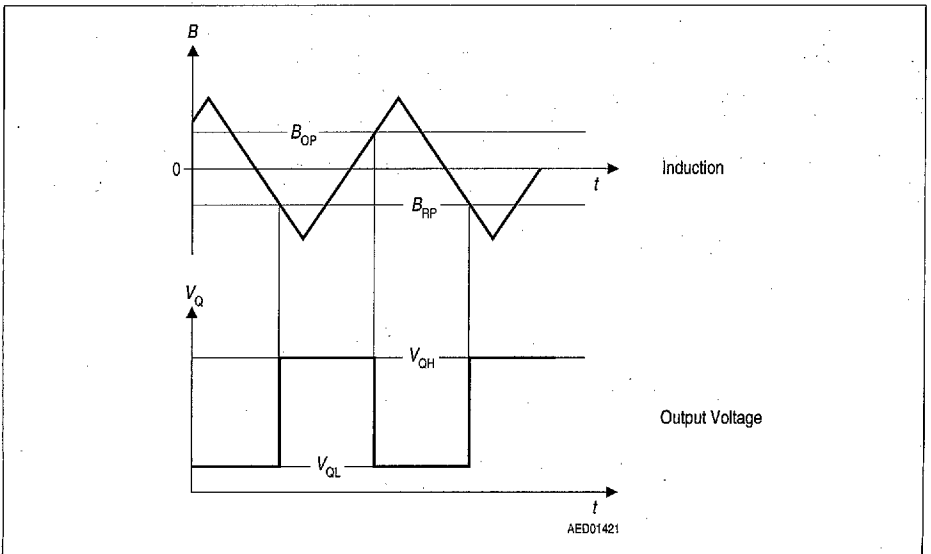

**Figure 6 Switching Characteristics Bipolar Type**

### Absolute Maximum Ratings

$T_j = -40$  to  $150$  °C

Parameter	Symbol	Limit Values		Unit	Remarks
		min.	max.		
Supply voltage	$V_S$	-40	32	V	-
Supply voltage	$V_S$	-	40	V	$t < 400$ ms; $v = 0.1$
Output voltage	$V_Q$	-	32	V	-
Output current	$I_Q$	-	100	mA	-
Output reverse current	$-I_Q$	-	100	mA	-
Junction temperature	$T_j$	-40	150	°C	-
Storage temperature	$T_{stg}$	-50	150	°C	-
Thermal resistance	$R_{th,JA}$		100	K/W	-

*Note: Stresses above those listed here may cause permanent damage to the device. Exposure to absolute maximum rating conditions for extended periods may affect device reliability.*

### Operating Range

Parameter	Symbol	Limit Values		Unit	Remarks
		min.	max.		
Supply voltage	$V_S$	4.0	18	V	-
Junction temperature	$T_j$	-40	125	°C	-

*Note: In the operating range the functions given in the circuit description are fulfilled.*

■ 8235605 0134280 8T0 ■

### AC/DC Characteristics

$4.0\text{ V} \leq V_S \leq 24\text{ V}$ ;  $-40\text{ }^\circ\text{C} \leq T_j \leq 150\text{ }^\circ\text{C}$

Parameter	Symbol	Limit Values			Unit	Test Condition	Test Circuit
		min.	typ.	max.			
Supply current	$I$	1.6	–	5.0	mA		1
	$I_{\text{SHigh}}$	–	2.5	–	mA	$B < B_{\text{RP}}$	1
	$I_{\text{SLow}}$	–	3.5	–	mA	$B > B_{\text{OP}}$	1
Output saturation voltage	$V_{\text{QSat}}$	–	0.25	0.5	V	$I_{\text{Q}} = 40\text{ mA}$	1
Output leakage current	$I_{\text{QL}}$	–	–	10	$\mu\text{A}$	$V_{\text{Q}} = 18\text{ V}$	1
Rise/fall time	$t_r / t_f$	–	–	1	$\mu\text{s}$	$R_L = 1.2\text{ k}\Omega$ $C_L \leq 33\text{ pF}$	1

*Note: The listed characteristics are ensured over the operating range of the integrated circuit. Typical characteristics specify mean values expected over the production spread. If not otherwise specified, typical characteristics apply at  $T_j = 25\text{ }^\circ\text{C}$  and the given supply voltage.*

*Note: Moderate changes may occur during the development process or customer discussion.*

8235605 0134281 737

**Magnetic Characteristics**

4.0 V ≤ V<sub>S</sub> ≤ 24 V

Parameter	Symbol	Limit Values								Unit
		TLE 4905 unipolar		TLE 4935 bipolar latch		TLE 4935-2 bipolar latch		TLE 4945-2 bipolar switch		
		min.	max.	min.	max.	min.	max.	min.	max.	

**Junction Temperature T<sub>j</sub> = -40 °C**

Turn-ON induction	B <sub>OP</sub>	7.5	19	10	20	15	27	-3	6	mT
Turn-OFF induction	B <sub>RP</sub>	5.5	17	-20	-10	-27	-15	-6	3	mT
Hysteresis (B <sub>OP</sub> -B <sub>RP</sub> )	ΔB <sub>HY</sub>	2	6.5	20	40	30	54	1	5	mT

**Junction Temperature T<sub>j</sub> = 25 °C**

Turn-ON induction	B <sub>OP</sub>	7	18	10	20	14	26	-3	6	mT
Turn-OFF induction	B <sub>RP</sub>	5	16	-20	-10	-26	-14	-6	3	mT
Hysteresis (B <sub>OP</sub> -B <sub>RP</sub> )	ΔB <sub>HY</sub>	2	6	20	40	28	52	1	5	mT

**Junction Temperature T<sub>j</sub> = 85 °C**

Turn-ON induction	B <sub>OP</sub>	6.5	17.5	10	20	13	26	-3	6	mT
Turn-OFF induction	B <sub>RP</sub>	4.5	15	-20	-10	-26	-13	-6	3	mT
Hysteresis (B <sub>OP</sub> -B <sub>RP</sub> )	ΔB <sub>HY</sub>	2	5.5	20	40	26	52	1	5	mT

**Junction Temperature T<sub>j</sub> = 125 °C**

Turn-ON induction	B <sub>OP</sub>	6	17	10	20	12	25	-3	6	mT
Turn-OFF induction	B <sub>RP</sub>	4	14	-20	-10	-25	-12	-6	3	mT
Hysteresis (B <sub>OP</sub> -B <sub>RP</sub> )	ΔB <sub>HY</sub>	2	5	20	40	24	50	1	5	mT

Note: The listed characteristics are ensured over the operating range of the integrated circuit. Typical characteristics specify mean values expected over the production spread. If not otherwise specified, typical characteristics apply at T<sub>j</sub> = 25 °C and the given supply voltage.

8235605 0134282 673



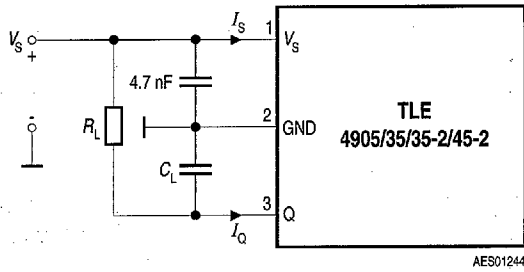

Unipolar Type TLE 4905

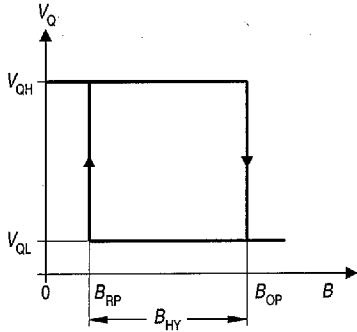

Bipolar Type TLE 4935

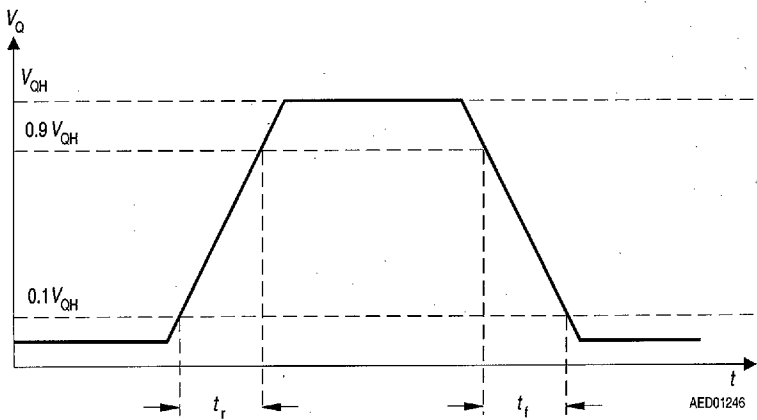
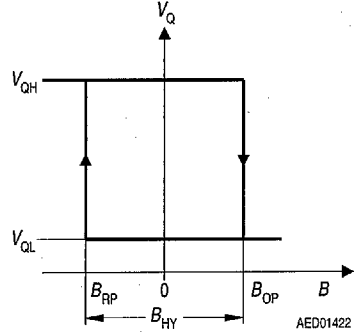
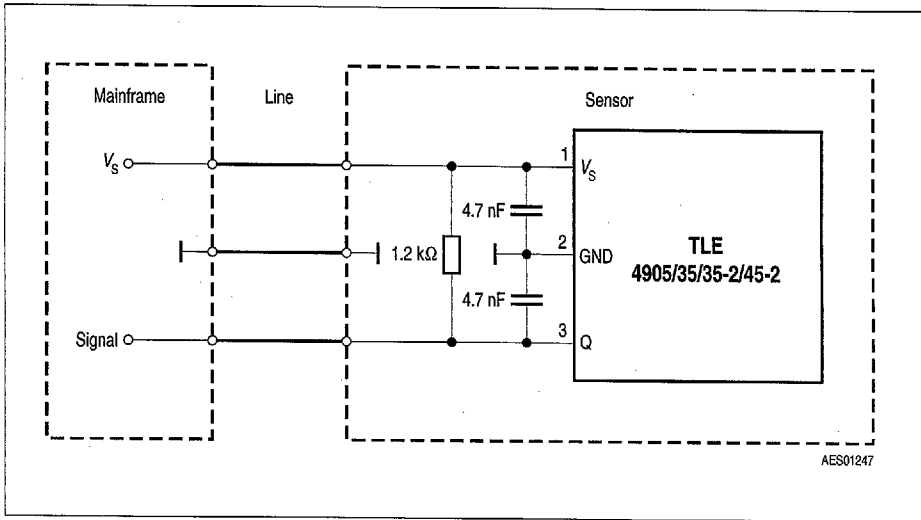

Figure 7 Test Circuit 1

8235605 0134283 50T

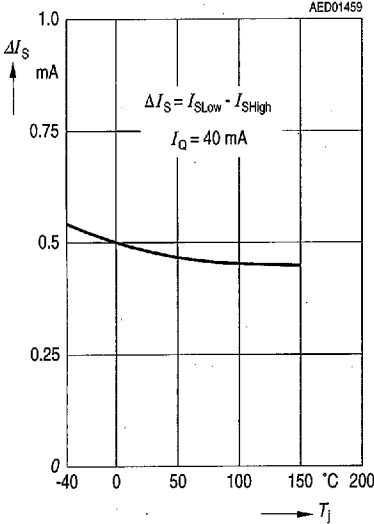

**Figure 8 Application Circuit**

8235605 0134284 446

If not otherwise specified, all curves reflect typical values at  $T_j = 25^\circ\text{C}$  and  $V_S = 12\text{ V}$ .

**Quiescent Current Difference versus Temperature**



**Saturation Voltage versus Output Current**

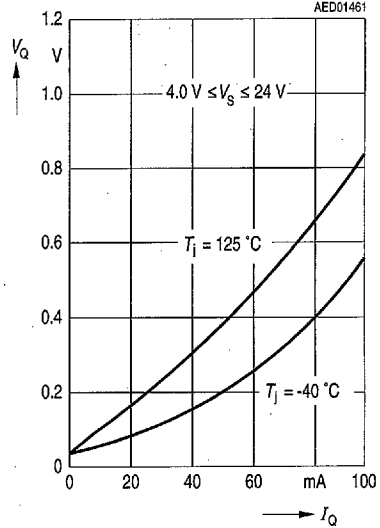

**Quiescent Current versus Junction Temperature**

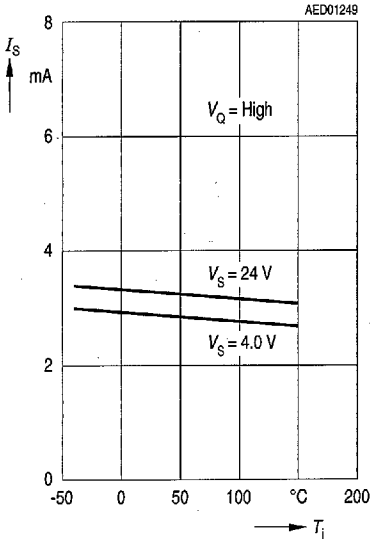

**TLE 4905 Operate-and Release-Point versus Junction Temperature**

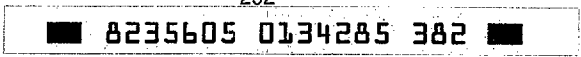
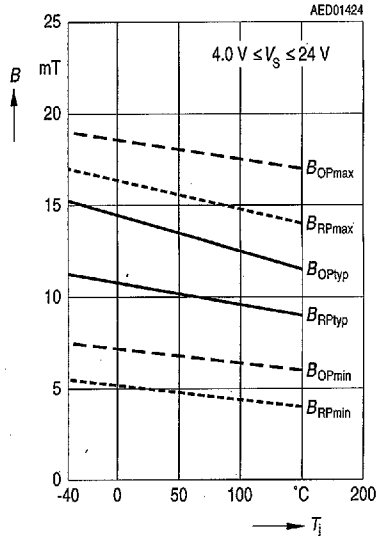

**TLE 4935 Operate-and Release-Point versus Junction Temperature**

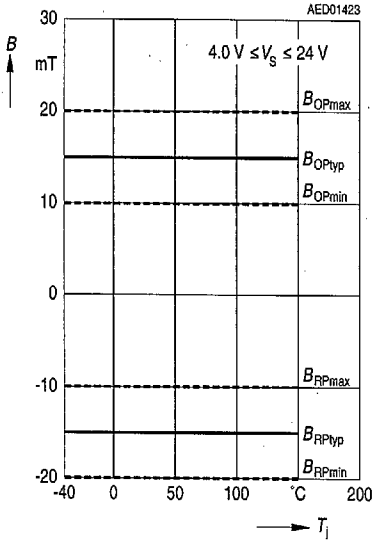

**TLE 4935-2 Operate-and Release-Point versus Junction Temperature**

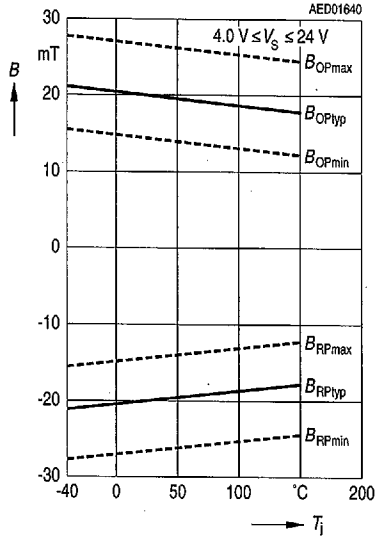

**TLE 4905 Hysteresis versus Junction Temperature**

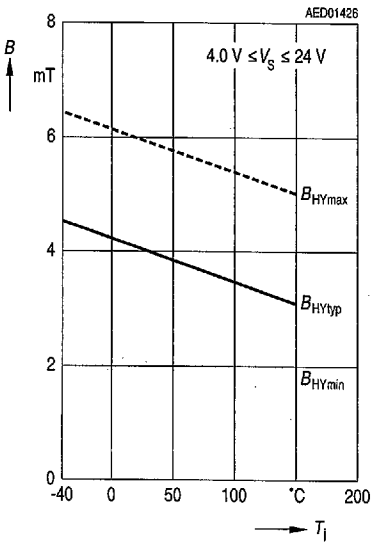

**TLE 4945-2 Operate-and Release-Point versus Junction Temperature**

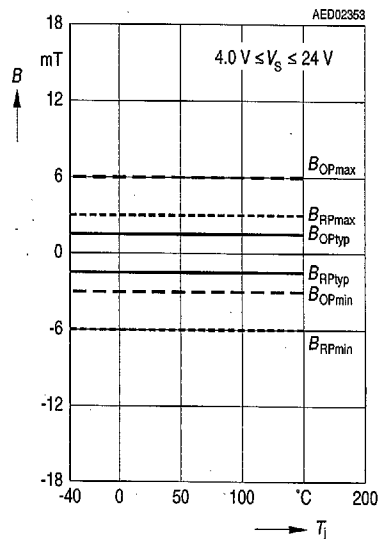

**Package Outline**

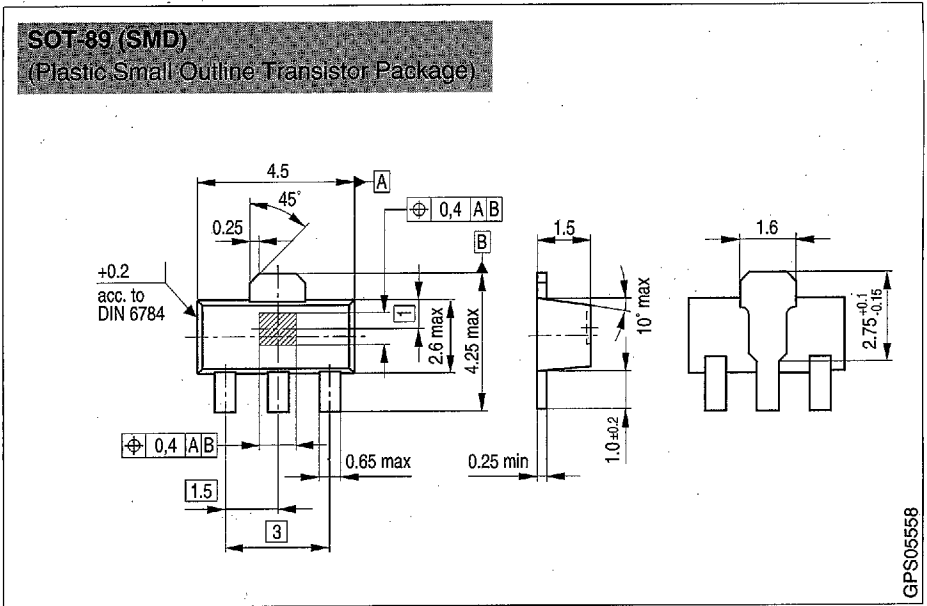

**Package Information**

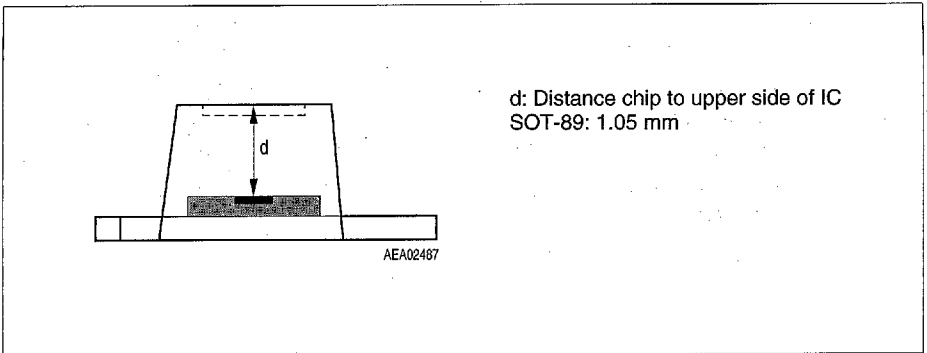

**Sorts of Packing**

Package outlines for tubes, trays etc. are contained in our Data Book "Package Information".

**SMD** = Surface Mounted Device

Dimensions in mm